



FIRE SUPPRESSION

SALES DATA SHEET

1.25KG Novec 1230 Gas Handheld Extinguisher

Model Number: FE-NOVEC1250HH-MB, FE-NOVEC1250HH-MG and FE-NOVEC1250HH



Installation Kit Contents: 1 x Wire Bracket, 2 x Stainless Steel Straps

Model Number FE-NOVEC1250HH-MB	Part Number 100.200.052
Model Number FE-NOVEC1250HH-MG	Part Number 100.200.051
Model Number FE-NOVEC1250HH	Part Number 100.200.045
Content	NOVEC 1230 – Clean Gas
Capacity	1.25kg
Total weight	2.0kg
Cylinder	Aluminium
Size (w x d x h)	90x100x355
Pressure	Stored Pressure 9 Bar
Operating Temperature range	-15 to +60°C
Distance	1.5 to 2.5 metres
Maintenance/Service	<p>Every 6 months check that the nozzle is clear, the seal is intact and pressure reading is in the green zone. If seal is broken or pressure is in the red zone – withdraw from service and contact manufacturer.</p> <p>Return to Manufacturer (or an approved Service Agent) when service required, or after complete or partial discharge</p>

Fire Extinguisher Valve Co Ltd

Unit B3 Ford Airfield Industrial Estate, Ford, Nr Arundel, West Sussex BN18 0HY

Tel +44 (0) 1243 55 55 66 Fax +44 (0) 1243 555 660

Email sales@f-e-v.co.uk Web www.f-e-v.co.uk

SALES DATA SHEETS 2020/ NOVEC HAND HELD / Novec 1.25KG Handheld – Version 1 – June 2020



FIRE SUPPRESSION

NOVEC1250HH

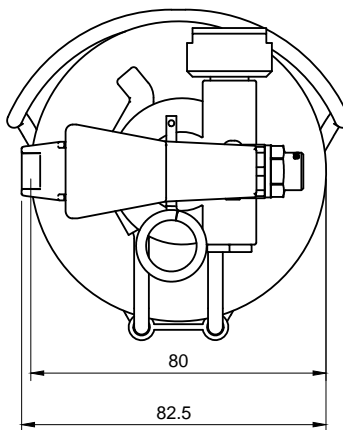
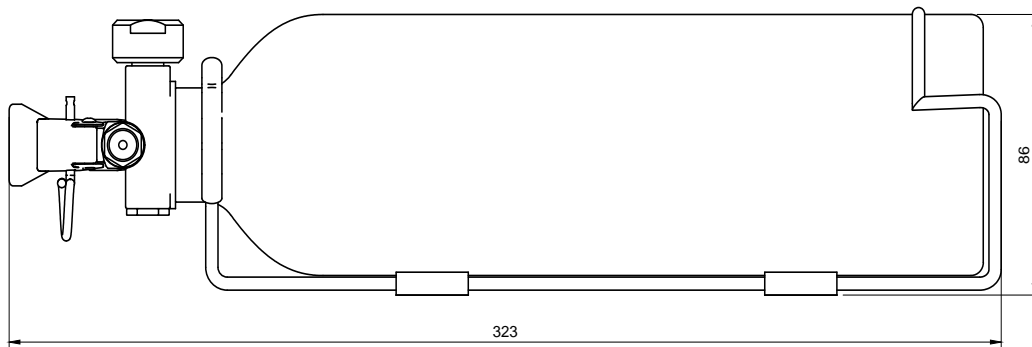

Fire Extinguisher Valve Co Ltd
Unit B3 Ford Airfield Industrial Estate, Ford, Nr Arundel, West Sussex BN18 0HY
Tel +44 (0) 1243 55 55 66 Fax +44 (0) 1243 555 660
Email sales@f-e-v.co.uk Web www.f-e-v.co.uk
SALES DATA SHEETS 2020/ NOVEC HAND HELD / Novec 1.25KG Handheld – Version 1 – June 2020